

FEATURES:

- Energy meter, Class 1 (EN 61036)
- Single phase or three phase connection
- 7 -digit cyclometer register
- 90° Analogue pointer meter of power or power factor
- Microprocessor control
- Simultaneous measurement of two quantities
- Exchangeable scale
- Relay outputs
- Standard 96 x 96 mm DIN case
- Protective cover for terminals (optional)

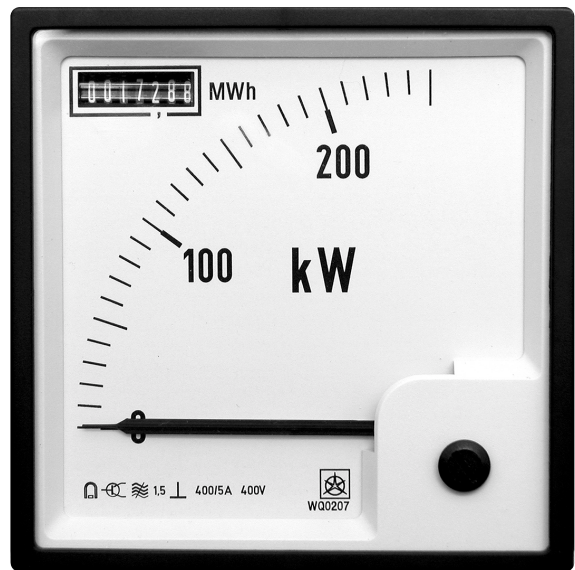

Picture 1: Panel Mounted kwh Meters WQ0207

APPLICATION

WQ0207 meters are intended for energy measurement in single phase or three phase systems, class 1 (EN 61036). They are built into a standard 96x96 mm DIN case. The meter is microprocessor controlled. Energy is displayed with 7-digit electromechanical register which retains the value also in case of auxiliary power supply failure. The instrument can be adapted to the applied current measuring transformers. Two instrument versions enable not only energy measurement but also simultaneous analogue display of momentary power value (active or reactive) or a power factor.

Single phase and three phase meters with optionally built in relay output are designed to send data directly to microprocessor based equipment which can be programmed to control and save energy. Meters with relay outputs are suitable for a wide range of applications including: energy management systems, maximum demand recorders, etc.

CONSTRUCTION

CASE

The casing is made of a black self-extinguished material with highly resistance to creep currents. The instrument front side is protected with a glass.

CONNECTION TERMINALS

At the instrument rear side are connection terminals. A connection part is divided into two parts. The upper part is intended for connection of single phase or three phase measuring system, and the lower part for connection of options (auxiliary supply and/or relay outputs). A connection diagram is on the instrument.

ENERGY DISPLAY

The electromechanical register consists of seven black segments. Numbers are white. They are 4 mm high and 1.2 mm wide.

OPERATION

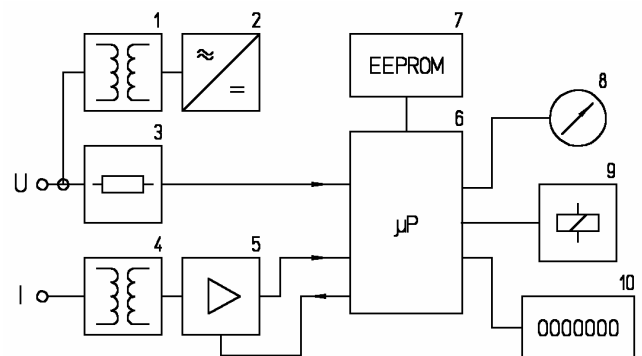

Picture 2: Block diagram

- | | |
|-----------------------------------|---------------------------|
| 1. Power supply transformer | 5. Current autorange |
| 2. Rectifier | 6. Microprocessor |
| 3. Voltage divider | 7. EEPROM |
| 4. Current measuring transformers | 8. Analogue pointer meter |
| | 9. Relay outputs |
| | 10. Register |

A sampling method of voltages and currents with A/D converter is used in the instrument. Voltages are connected via a voltage divider (3). Currents are electrically isolated with current measuring transformers (4). A built-in microprocessor (6) calculates rms currents, rms voltages and active power at the end of a period from sample values of voltages and currents. Other quantities (apparent power, reactive power, power factor) are calculated from these values. A microprocessor with a quartz crystal assures exact calculation of energy from power.

Data of the instrument version (transformer ratios, connection type, etc.) are stored in EEPROM (7), therefore the instrument can be programmed without opening.

Besides the data on the instrument version the calibration constants are stored in EEPROM. There are no setting components (trimmers) in the instrument which assures better long-term stability. A built-in current autorange (5) assures accuracy also in case of small currents. High sampling rate enables measurement of distorted signals.

Basic version of the instrument is provided with one electromechanical register (10).

The instrument can display not only the energy but also an instantaneous value of active power, reactive power or power factor of the measuring system by means of the 90° analogue pointer (8).

Two relay outputs (9) can be built in the instrument.

The frequency of the relay varies according to the energy consumed.

Instrument auxiliary power supply can be provided from the measuring system or separately (option). Power supply of the instrument is performed via a supply transformer (1) and a rectifier (2).

TECHNICAL DATA

ACCURACY CLASS:

- Energy **EN 61036** class 1
- Power $\pm 1\%$ of scale
- Power factor $\pm 2\%$ of scale

VOLTAGE INPUT:

- Standard rated voltages (U_n) 57, 100, 230, 400 V AC
- Optional rated voltage 50 to 400 V AC
- Voltage measuring range external auxiliary supply 0...1.5 U_n
- Voltage measuring range supply from a measuring system 0.8...1.2 U_n
- Self consumption of voltage input external auxiliary supply < 0.1 VA
- Self consumption of voltage input supply from a measuring system < 3.0 VA
- Rated frequency 50, 60 Hz
- Frequency range 45 to 65 Hz
- Overload at external auxiliary supply 2 U_n , 10 s

CURRENT INPUT:

- Rated current (I_n) 1A or 5 A
- Maximal current (I_{max}) 1.6 I_n
- Self-consumption of current input < 0.1 VA
- Overloads 3 I_n permanently
- Overload 25 I_n 3s
- Overload 50 I_n 1s

AUXILIARY SUPPLY (OPTION):

- Standard auxiliary voltages (U_{aux}) 57, 100, 230, 400 V AC
- Optional auxiliary voltages 50 ... 400 V AC
- Supply voltage range 0.8 ... 1.2 U_{aux}
- Consumption < 3 AV
- Overload 2 U_{aux} , 1 s

ELECTROMECHANICAL REGISTER:

- Number of digits 7
- Size of digits 4 x 1 .2 mm

RELAY OUTPUT:

- Relay 250 V, 6 A, 50 Hz
- Maximum switching power 1500 VA
- Standard number of relays 10, 100/kWh (MWh)
- Relay duration 100 ms

DESIGN:

- Case plastic, in compliance with **UL 94 V-0**
- Protection IP 52 (IP 00 for terminals) (IP 20 with protective cover)
- Safety in compliance with EN 61010-1
- **600 V** Installation category **II** Pollution degree 2
- **300 V** Installation category **III** Pollution degree 2
- Weight 0.6 kg

AMBIENT CONDITIONS **JVF (DIN 40 040)**

- Temperature: Reference range of operation 0 to 50°C
- Rated range of operation - 10 to 60°C
- Storing - 40 to 70°C
- Humidity up to 95% (without condensing)

EMC

- RFI (Radiated) **EN 61000-4-3**, 10 V/m
- EFT (Burst) **EN 61000-4-4**, level 4, 4 kV
- ESD (Electrostatic discharge) **EN 61000-4-2**, 8 kV

CONNECTION

The instrument connection can be, regarding the version, either single phase or three-phase, its load can be balanced or unbalanced, its measuring system can be performed either in 3 or 4-wire connection. Instrument power supply can be provided from the measuring system (self powered) via input terminals or with auxiliary supply (option).

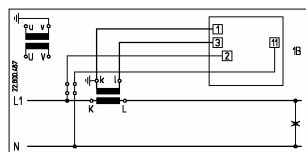

Picture 3: Single phase connection (1b)

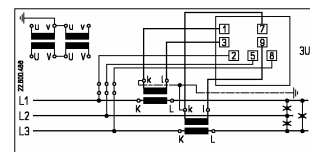

Picture 4: Three-phase connection (3u)

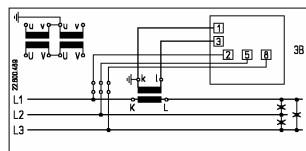

Picture 5: Three-phase connection (3b)

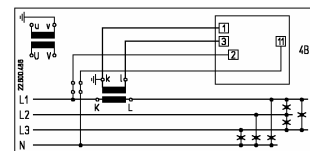

Picture 6: Three-phase connection (4b)

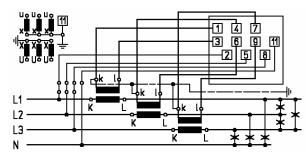

Picture 7: Three-phase connection (4u)

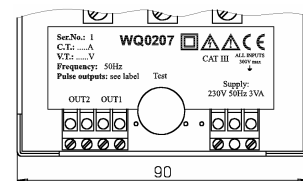

Picture 8: Optinal connections

DATA FOR ORDERING:

When ordering the instrument it is necessary to state its type, connection, voltage and current transformer ratio, rated input voltage, rated input current and additional options.

Basic data:

WQ0207 - bb, cccc/ddd V, eeee/f A, gg Hz, Rh, Eiii V

- bb 1 b - single phase connection
 3b - 3 phase, 3-wire connection with balance load
 3u - 3 phase, 3-wire connection with unbalance load
 4b - 3 phase, 4-wire connection with balance load
 4u - 3 phase, 4-wire connection with unbalance load

cccc/ primary voltage of a measuring transformer

ddd V rated voltage (57, 100, 230, 400 V)

eeee/ primary current of a measuring transformer

fA rated current (1, 5 A)

gg Hz rated frequency (50, 60 Hz)

h number of relay outputs (0, 1, 2)

iii AC external power supply (57 100, 230, 400)

Additional data for each register and relay output:

ab cd, eeee relays/ffff

a C - register

R - relay

b register or relay number (1, 2)

c A - active energy meter

R - reactive energy meter

d I - import energy meter

E - export energy meter

eeee number of relays for energy unit

ffff energy unit (kWh (kvarh), MWh (Mvarh))

Additional data for analogue display (WQ0207):

a bbbb...cccc

a P - active power display

Q - reactive power display

F - power factor display

bbbb initial scale value

cccc final scale value

EXAMPLE FOR ORDERING

Basic data for energy meter with 90° analogue pointer meter in 3 phase 4-wire system with unbalance load, with 10,000/100 V VT, with 100/5 CT, 50 Hz frequency, with one relay output and with 230 V external auxiliary supply are:

WQ0207- 4u, 10k/100 V, 100/5 A, 50 Hz, R1, E230 V

Additional data for register and one relay output for active energy with 100 relays per MWh are:

C1 AI, 100 relays/MWh

R1 AI, 100 relays/MWh

Additional data for analogue pointer meter for active power from 0 to 2 MW are:

A 0...2 MW

DIMENSIONAL DRAWING:

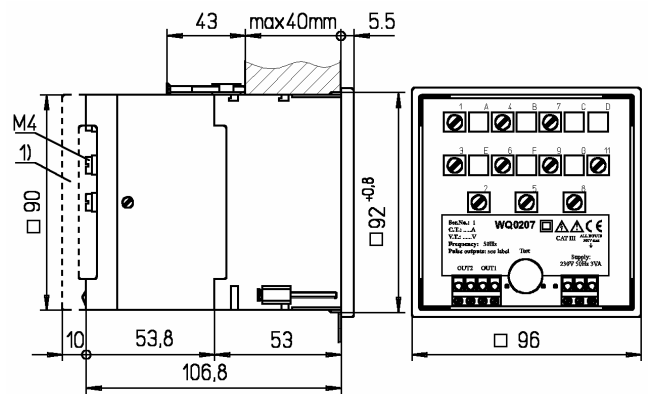

Picture 9: Dimensional drawing (all dimensions are in mm)



Ljubljanska c. 24a
 SI-4000 Kranj
 Slovenia
 tel.: +386 4 237 21 40
 fax: +386 4 237 21 29
 e-mail: info@iskra-mis.si
 www.iskra-mis.si

