

**FEATURES:**

- Active energy meter, class 1 (EN 61036)
- Reactive energy meter, class 2 (EN 61268)
- Single phase or three-phase connection
- 2 lines x 9 digits energy display on LCD
- Microprocessor control
- Simultaneous measurement and display of two quantities
- Interchangeable scale
- Programmable CT ratio (with set for changing CT)
- Relay outputs (optional)
- Standard 96 x 96 mm DIN case
- Protective cover for terminals

**APPLICATION**

WQ1247 meters are intended for energy measurement in single phase and three-phase systems, class 1. They are built into a standard 96x96 mm DIN casing. The meter is microprocessor controlled. Energy is displayed with 9-digit LCD which retains the value also in case of auxiliary power supply failure. The instrument can be adapted to the applied current measuring transformers.

Single phase or three-phase meters with optionally built-in relay outputs are designed to send data directly to microprocessor based equipment which can be programmed to control and save energy. Meters with relay outputs are suitable for a wide range of applications including: energy management systems, maximum demand recorders, etc.

**CONSTRUCTION**

**CASE**

WQ1247 meter is available in the version as shown on the front page of this prospectus. The casing is made of a black self-extinguished material with highly resistance to creep currents. The instrument front side is protected with a glass.

**CONNECTION TERMINALS**

At the instrument rear side are connection terminals. A connection part is divided into two parts. The upper part is intended for connection of single phase or three-phase measuring system, and the lower part for connection of options (auxiliary supply and/or relay outputs). A connection diagram is provided on the instrument.

**ENERGY DISPLAY**

The LCD display consists of 2 lines with 16 digits (9 digits are used for energy value display). Digits are 4.86 mm high and 2.96 mm wide.



Picture 1: Energy Meter WQ1247

**OPERATION**

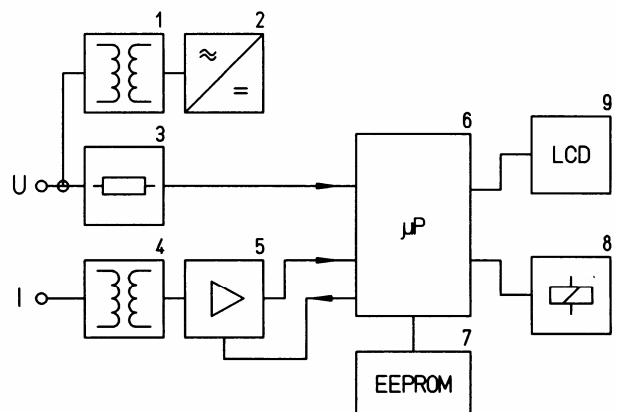

Picture 2: Block diagram

- |                                   |                      |
|-----------------------------------|----------------------|
| 1. Power supply transformer       | 5. Current autorange |
| 2. Rectifier                      | 6. Microprocessor    |
| 3. Voltage divider                | 7. EEPROM            |
| 4. Current measuring transformers | 8. LCD               |
|                                   | 9. Relay outputs     |

A sampling method of voltages and currents with A/D converter is used in the instrument. Voltages are connected via a voltage divider (3). Currents are electrically isolated with current measuring transformers (4). A built-in microprocessor (6) calculates rms currents, rms voltages and active power at the end of a period from sample values of voltages and currents. Other quantities (apparent power, reactive power, power factor) are calculated from these values. A microprocessor with a quartz crystal assures exact calculation of energy from power.

Data of the instrument version (transformer ratios, connection type, etc.) are stored in EEPROM (7), therefore the instrument can be programmed without opening. Besides the data on the instrument version the calibration constants are stored in EEPROM. There are no setting

components (trimmers) in the instrument which assures better long-term stability.

A built-in current autorange (5) assures accuracy also in case of small currents. High sampling rate enables measurement of distorted signals.

Two relay outputs (9) can be built in the instrument. The frequency of the relay varies according to the energy consumed. Instrument power supply can be provided from the measuring system (self powered) or auxiliary (option). Power supply of the instrument is performed via a supply transformer (1) and a rectifier (2).

### SETTING OF CURRENT RATIO

The instrument design allows the qualified user to change a current ratio by the Set for changing CT and reset counters. This set includes connection to the instrument with a pushbutton, a protective cover and User's Manual. More detailed description of setting is provided in the »User's Manual« which is enclosed to the set.

### TECHNICAL DATA

- Active energy **EN 61036** class 1
- Reactive energy **EN 61268** class 2

### VOLTAGE INPUT:

- Standard rated voltages ( $U_n$ ) 57 V, 110 V, 230 V, 400 V
- Optional rated voltage 50 V ... 400 V
- Voltage input range auxiliary supply 0 ... 1.5  $U_n$
- supply from a measuring system 0.8 ... 1.2  $U_n$
- Self consumption of voltage input with auxiliary supply < 0.1 VA
- supply from a measuring system < 3.0 VA
- Rated frequency 50 Hz, 60 Hz
- Frequency range 45 Hz to 65 Hz
- Overload at auxiliary supply 2 x  $U_n$ , 10 s

### CURRENT INPUT

- Rated current ( $I_n$ ) 1 A or 5 A
- Maximal current ( $I_{max}$ ) 1,6 x  $I_n$
- Self-consumption of current input < 0,1 VA
- Overloads continuously 3 x  $I_n$
- 25 x  $I_n$  3s
- 50 x  $I_n$  1s

### AUXILIARY SUPPLY (OPTION):

- Standard auxiliary voltages ( $U_{aux}$ ) 57 V, 110V, 230V, 400 V AC
- Optional auxiliary voltages 50 V ... 400 V AC
- Supply voltage range 0,8 ... 1,2  $U_{aux}$
- Consumption < 3 VA
- Overload 2 x  $U_{aux}$ , 1 s

### DISPLAY:

- LCD 2 lines
- Number of digits 16 digits
- Height of digits 4.86 mm
- Width of digits 2.96 mm

### RELAY OUTPUT:

- Relay 250 V, 6 A, 50 Hz
- Maximum switching power 1500 VA
- Maximal number of relays 4000 per hour
- Relay duration 100 ms

### DESIGN:

- Case plastic, in compliance with **UL 94 V-0**
- Protection IP 52 (IP 00 for terminals) (IP 20 with protective cover)
- Safety in compliance with EN 61010-1
- 600 V** Installation category **II**
- Pollution degree 2
- 300 V** Installation category **III**
- Pollution degree 2
- Weight 0.5 kg

### AMBIENT CONDITIONS

**JVF (DIN 40 040)**

- Temperature Reference range of operation 0 to 50°C
- Rated range of operation - 10 to 60°C
- Storing - 40 to 70°C
- Humidity up to 95% (without condensing)

### EMC

- RFI (Radiated) **EN 61000-4-3**, 10 V/m
- EFT (Burst) **EN 61000-4-4**, level 4, 4 kV
- ESD (Electrostatic discharge) **EN 61000-4-2**, 8 kV

### CONNECTION

The instrument connection can be, regarding the version, either single phase or three-phase, its load can be balanced or unbalanced, its measuring system can be performed either in 3 or 4-wire connection. Instrument power supply can be provided from the measuring system (self powered) via input terminals or with auxiliary supply (option).

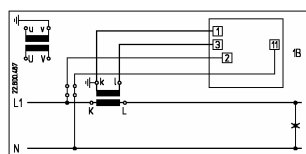

Picture 3: Single phase connection (1b)

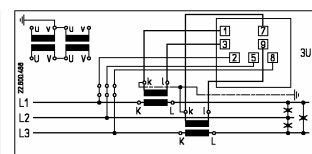

Picture 4: Three-phase connection (3u)

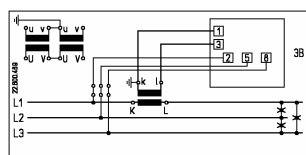

Picture 5: Three-phase connection (3b)

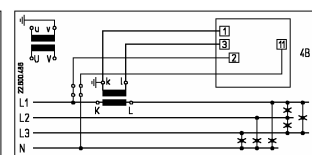

Picture 6: Three-phase connection (4b)

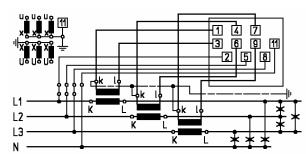

Picture 7: Three-phase connection (4u)

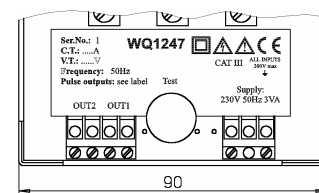

Picture 8: Optinal connections

## DATA FOR ORDERING:

When ordering the instrument it is necessary to state its type, connection, voltage and current transformer ratio, rated input voltage, rated input current and additional options.

Basic data:

WQ1247 – bb, cccc/ddd V, eeee/f A, gg Hz, Rh, Eiii V

- bb 1b – single phase connection  
 3b – 3-phase, 3-wire connection with balanced load  
 3u – 3-phase, 3-wire connection with unbalanced load  
 4b – 3-phase, 4-wire connection with balanced load  
 4u – 3-phase, 4-wire connection with unbalanced load

cccc/ primary voltage of a measuring transformer

ddd V rated voltage (57, 100, 230, 400 V)

eeee/ primary current of a measuring transformer

f A rated current (1, 5 A)

gg Hz rated frequency (50, 60 Hz)

h number of relay outputs (0, 1, 2)

iii AC auxiliary power supply (57, 100, 230, 400)

Additional data for each relay output:

ab cd, eeee relays/ffff

a R – relay

b relay number (1, 2)

c A – active energy meter

R – reactive energy meter

d I – import energy meter

E – export energy meter

eeee number of relays for energy unit

ffff energy unit (kWh (kvarh), MWh (Mvarh))

## EXAMPLE FOR ORDERING

Basic data for energy meter WQ1247 in 3-phase 4-wire system with unbalanced load, with 10,000/100 V VT, with 100/5 CT, 50 Hz frequency, with two relay outputs (each output has 100 relays per MWh; relay 1 active import, relay 2 active export) and with 230 V auxiliary supply are:

WQ1247– 4u, 10k/100 V, 100/5 A, 50 Hz, R2 E230 V

R1 AI 100 relays/MWh

R2 AE 100 relays/MWh

## DIMENSIONAL DRAWING:

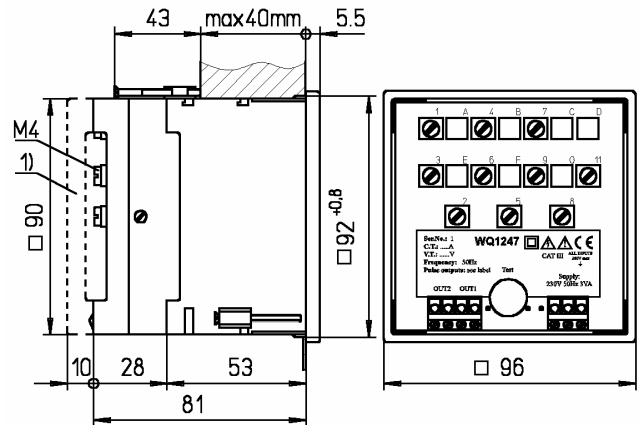

Picture 9: Dimensional drawing (all dimensions are in mm)

 **Iskra**  
Iskra MIS, d.d.

Ljubljanska c. 24a  
 SI-4000 Kranj  
 Slovenia  
 tel.: +386 4 237 21 40  
 fax: +386 4 237 21 29  
 e-mail: info@iskra-mis.si  
 www.iskra-mis.si

